

Natural light Closest to the Sunlight

## SunLike COB Series

### SAWS1564A

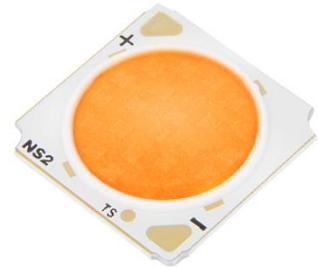

## Product Brief

### Description

- The SunLike COB series deliver natural sunlight spectrum.
- It is especially designed light source for human centric lighting.
- It's thermal management is excellent than other power LED solutions with wider Metal area.
- SunLike series are ideal light sources for commercial lightings including shop, museum, hospital and other premium light quality required applications.

### Features and Benefits

- CRI typ. 97 (on the BBL)
- Size 19mm \* 19mm
- LES 14.5mm
- MacAdam 3-step binning
- Uniformed Shadow
- Excellent thermal management
- RoHS compliant
- UL recognized component(E359235)

### Key Applications

- Commercial – Spot, Downlight
- Replacement lamps – bulb, PAR, MR16
- Industrial
- Residential

Table 1. Product Selection Table

Part Number	CCT		CRI
	Color	Typ.	Typ.
SAWS1564A	Cool White	6500K	97
		5000K	97
	Neutral White	4000K	97
		3500K	97
	Warm White	3000K	97
		2700K	97

## Table of Contents

Index	
• Product Brief	1
• Table of Contents	2
• Performance Characteristics	3
• Characteristics Graph	5
• Color Bin Structure	14
• Mechanical Dimensions	16
• Packaging Specification	17
• Product Nomenclature (Labeling Information)	19
• Handling of Silicone Resin for LEDs	20
• Precaution for Use	21
• Company Information	24

## Performance Characteristics

**Table.2 Electro Optical Characteristics, T<sub>j</sub>=85°C**

Part Number	CCT (K) <sup>[1]</sup>	Typical Luminous Flux <sup>[2]</sup> Φ <sub>v</sub> <sup>[3]</sup> (lm)	Typical Forward Voltage (V <sub>F</sub> ) <sup>[4]</sup>	CRI <sup>[5]</sup> , R <sub>a</sub>	Viewing Angle (degrees) 2θ ½
	Typ.	0.43A	0.43A	Typ.	Typ.
SAWS1564A	6500	1806	35.0	97	115
	5000	1738	35.0	97	115
	4000	1687	35.0	97	115
	3500	1659	35.0	97	115
	3000	1574	35.0	97	115
	2700	1547	35.0	97	115

### Notes :

- (1) Correlated Color Temperature is derived from the CIE 1931 Chromaticity diagram.  
Color coordinate : ±0.005, CCT ±5% tolerance.
- (2) Seoul Semiconductor maintains a tolerance of ±7% on flux and power measurements.
- (3) Φ<sub>v</sub> is the total luminous flux output as measured with an integrating sphere.
- (4) Tolerance is ±3% on forward voltage measurements.
- (5) Tolerance is ±2 on CRI measurements.

\* For reference only.

## Performance Characteristics

**Table.3 Absolute Maximum Ratings**

Parameter	Symbol	Value			Unit
		Min.	Typ.	Max.	
Forward Current	$I_F$	-	0.43	0.86	A
Power Dissipation	$P_d$	-	15.1	33.2	W
Junction Temperature	$T_j$	-	-	125	°C
Operating Temperature	$T_{opr}$	- 40	-	85	°C
Surface Temperature	$T_S$	- 40	-	105	°C
Storage Temperature	$T_{stg}$	- 40	-	105	°C
Thermal resistance (J to S) <sup>[1]</sup>	$R\theta_{J-S}$	-	0.5	-	K/W
ESD Sensitivity(HBM)		Class 3A JESD22-A114-E			

**Notes :**

(1) Thermal resistance :  $R\theta_{J-S}$  At thermal resistance, J to S means junction to COB's substrate bottom.

•LED's properties might be different from suggested values like above and below tables if operation condition will be exceeded our parameter range. Care is to be taken that power dissipation does not exceed the absolute maximum rating of the product.

•Thermal resistance can be increased substantially depending on the heat sink design/operating condition, and the maximum possible driving current will decrease accordingly.

•All measurements were made under the standardized environment of Seoul Semiconductor..

## Performance Characteristics

Fig 1. Color Spectrum

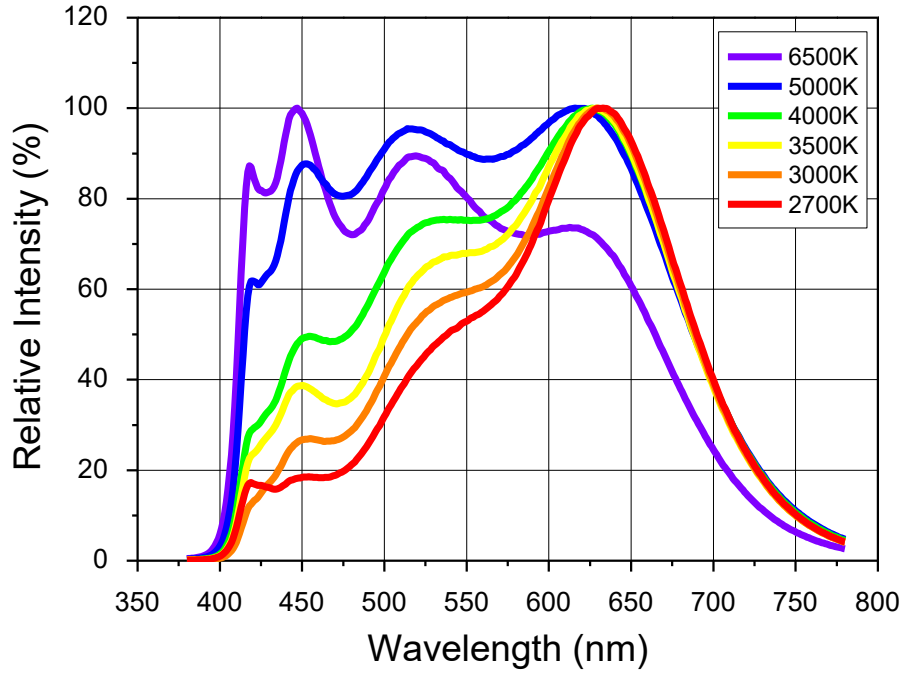

## Performance Characteristics

Fig 2. Radiant Pattern

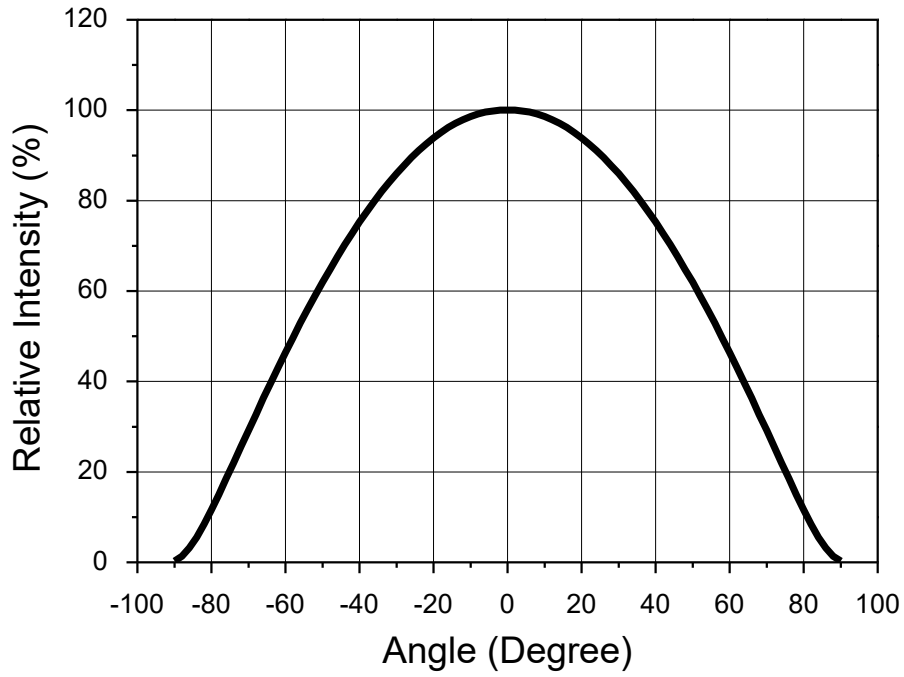

## Performance Characteristics

Fig 3. Forward Voltage vs. Forward Current,  $T_j=85^{\circ}\text{C}$

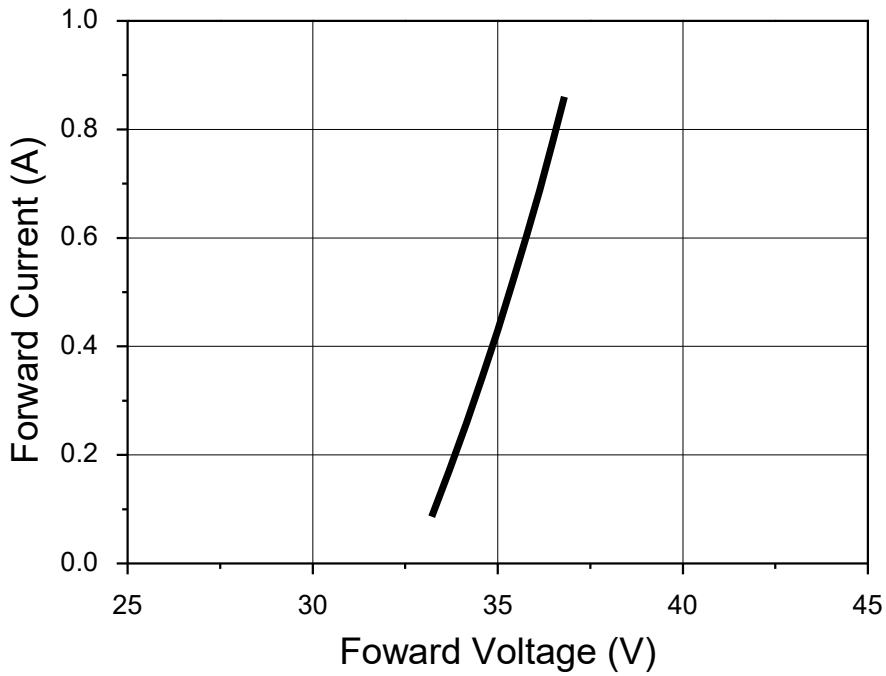
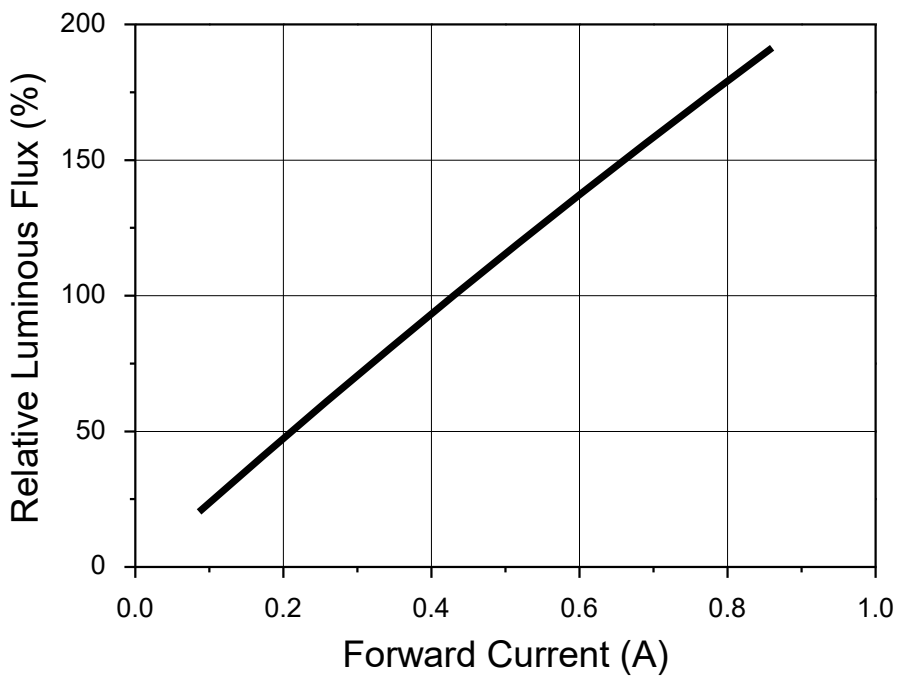

Fig 4. Forward Current vs. Relative Luminous Flux,  $T_j=85^{\circ}\text{C}$



## Performance Characteristics

Fig 5. Junction Temperature vs. Relative Luminous Flux,  $I_F=0.43A$

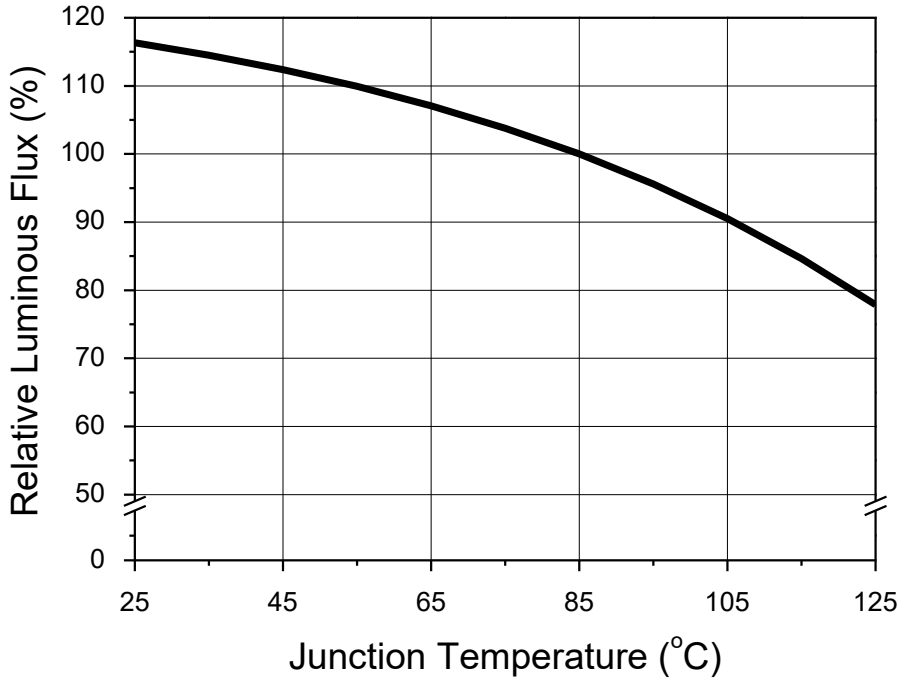
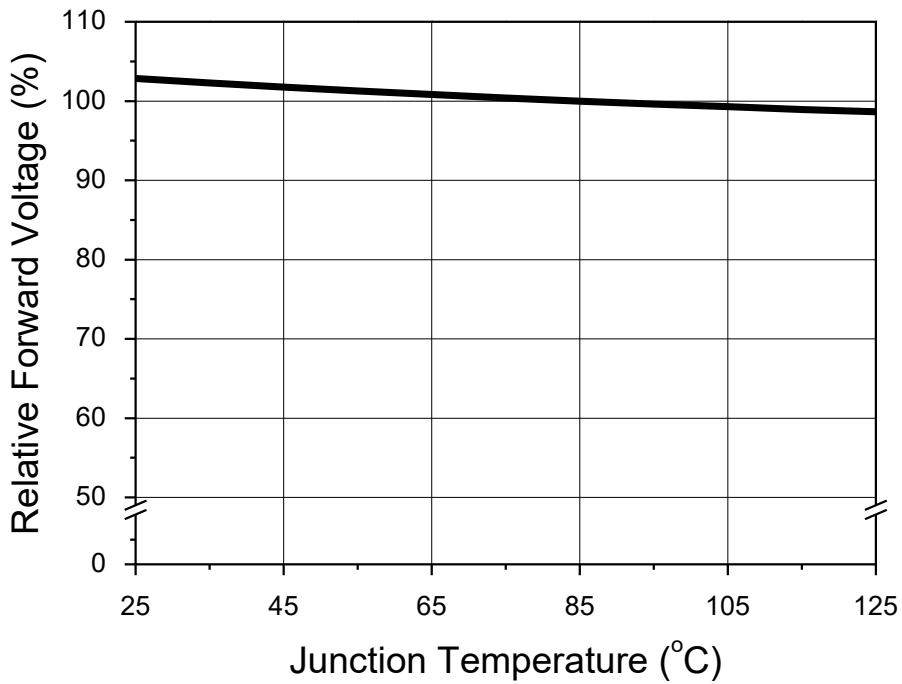

Fig 6. Junction Temperature vs. Forward Voltage,  $I_F=0.43A$





## Performance Characteristics

Fig 7. Junction Temperature vs. CIE x,y Shift,  $I_F=0.43A$  (5000K)

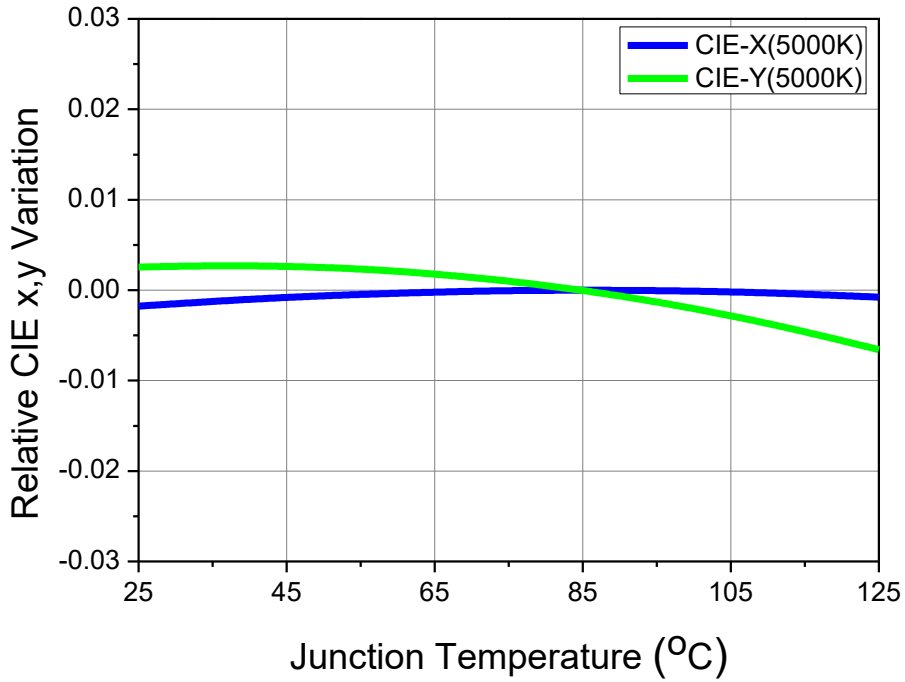
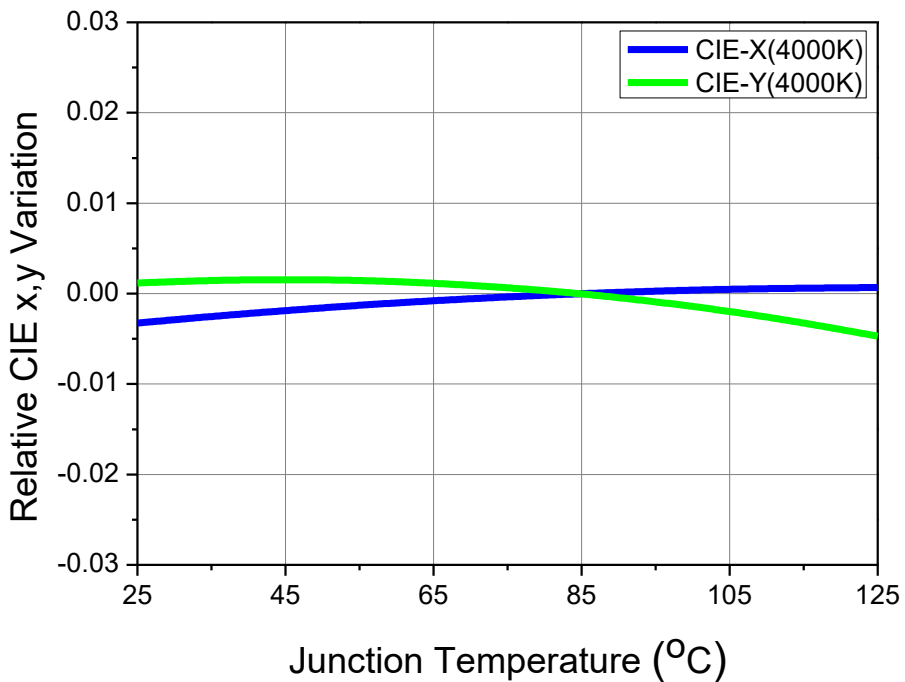
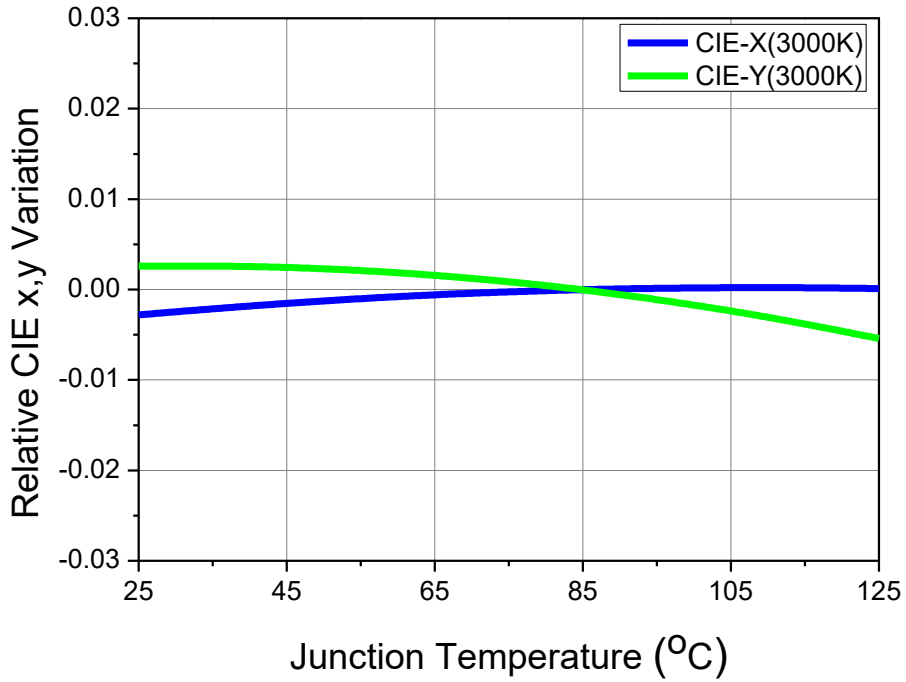

Fig 8. Junction Temperature vs. CIE x,y Shift,  $I_F=0.43A$  (4000K)



## Performance Characteristics

Fig 9. Junction Temperature vs. CIE x,y Shift,  $I_F=0.43A$  (3000K)



## Performance Characteristics

Fig 10. Forward Current vs. CIE x,y Shift,  $T_j=85^\circ\text{C}$  (5000K)

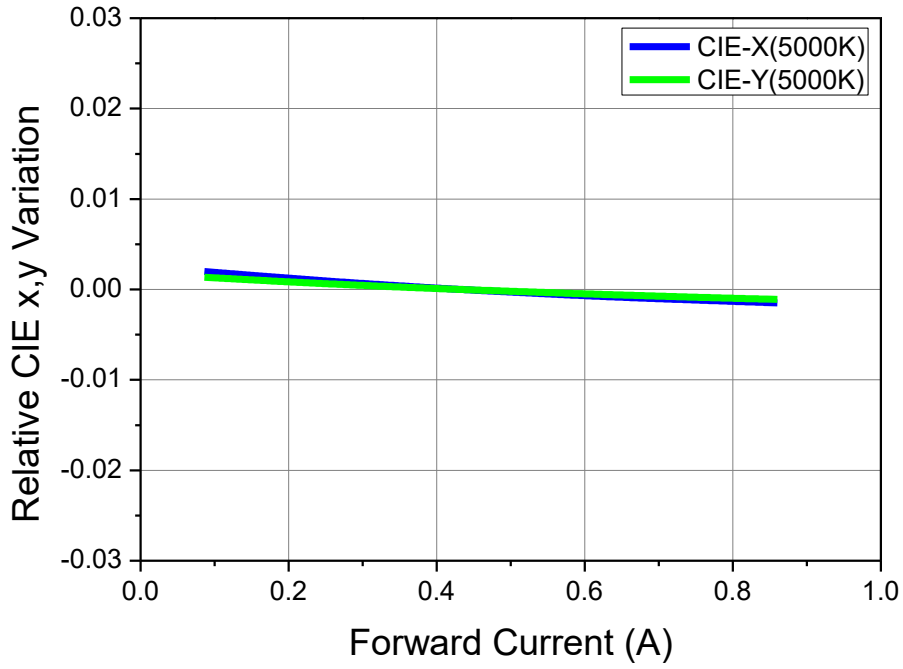
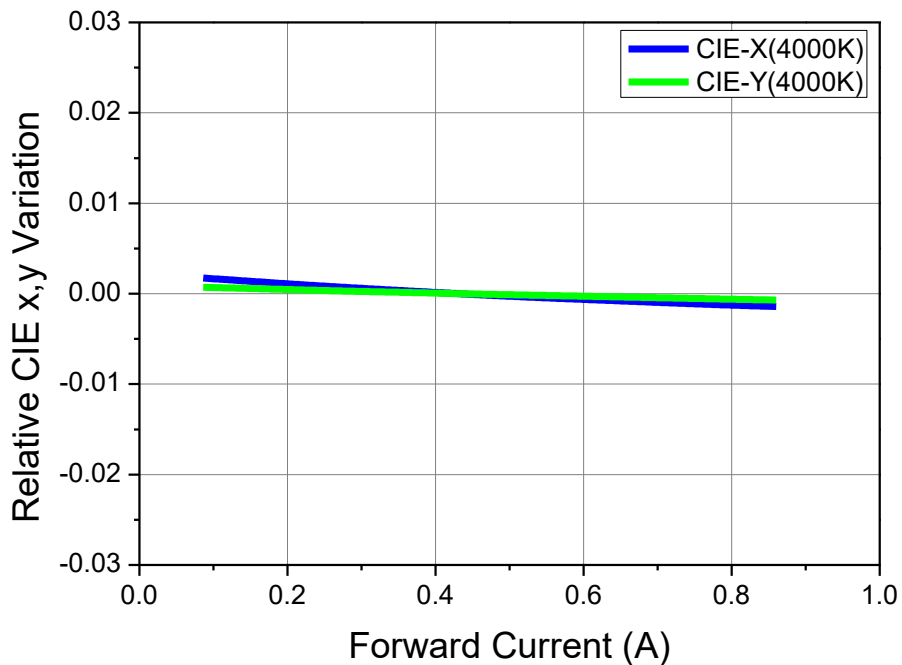
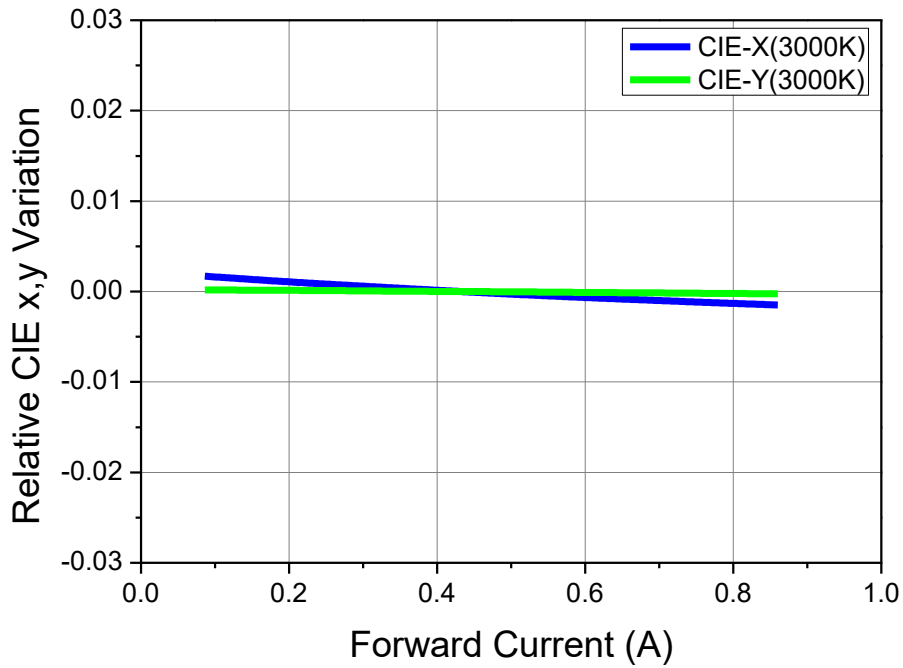

Fig 11. Forward Current vs. CIE x,y Shift,  $T_j=85^\circ\text{C}$  (4000K)



## Performance Characteristics

Fig 12. Forward Current vs. CIE x,y Shift,  $T_j=85^\circ\text{C}$  (3000K)



## Performance Characteristics

Fig 13. Surface Temperature vs. Maximum Forward Current,  $T_j(\text{max.})=125^\circ\text{C}$

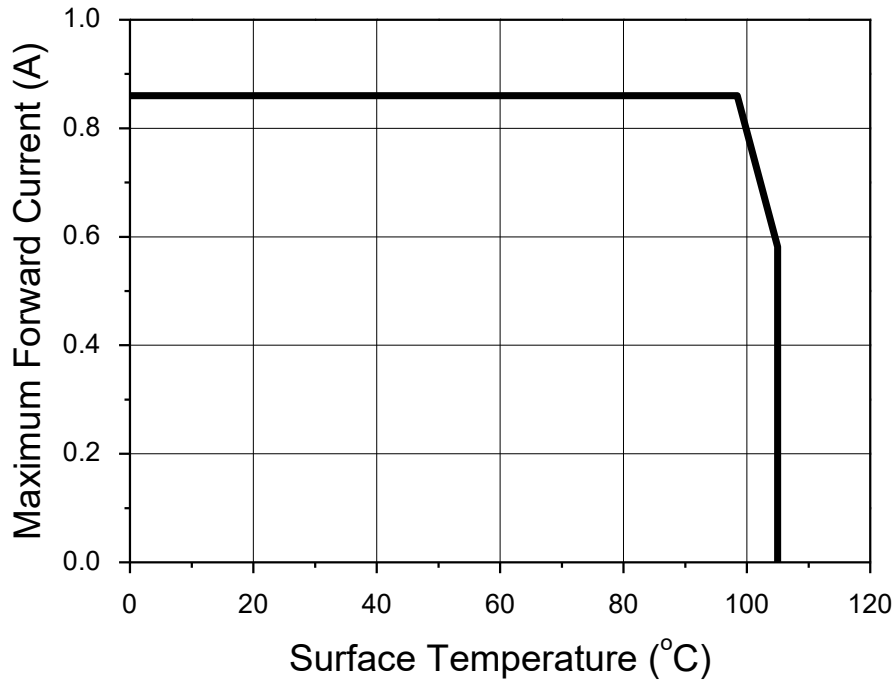

## Color Bin Structure

Table 4. Bin Code Description,  $T_j=85^\circ\text{C}$ ,  $I_f=0.43\text{A}$

Part Number	Luminous Flux (lm)			Color Chromaticity		Typical Forward Voltage (V)			CRI	
	Bin Code	Min.	Typ.	Bin Code	Typ. CCT	Bin Code	Min.	Max.	Bin Code	Typ.
SAWS1564A	B5	1680	1806	AE3	6500K	H	33.3	37.0	S	97
	B5	1616	1738	CE3	5000K	H	33.3	37.0	S	97
	B5	1569	1687	EE3	4000K	H	33.3	37.0	S	97
	B5	1543	1659	FE3	3500K	H	33.3	37.0	S	97
	B5	1464	1574	GE3	3000K	H	33.3	37.0	S	97
	B5	1439	1547	HE3	2700K	H	33.3	37.0	S	97

## Color Bin Structure

CIE Chromaticity Diagram,  $T_j=85^\circ\text{C}$

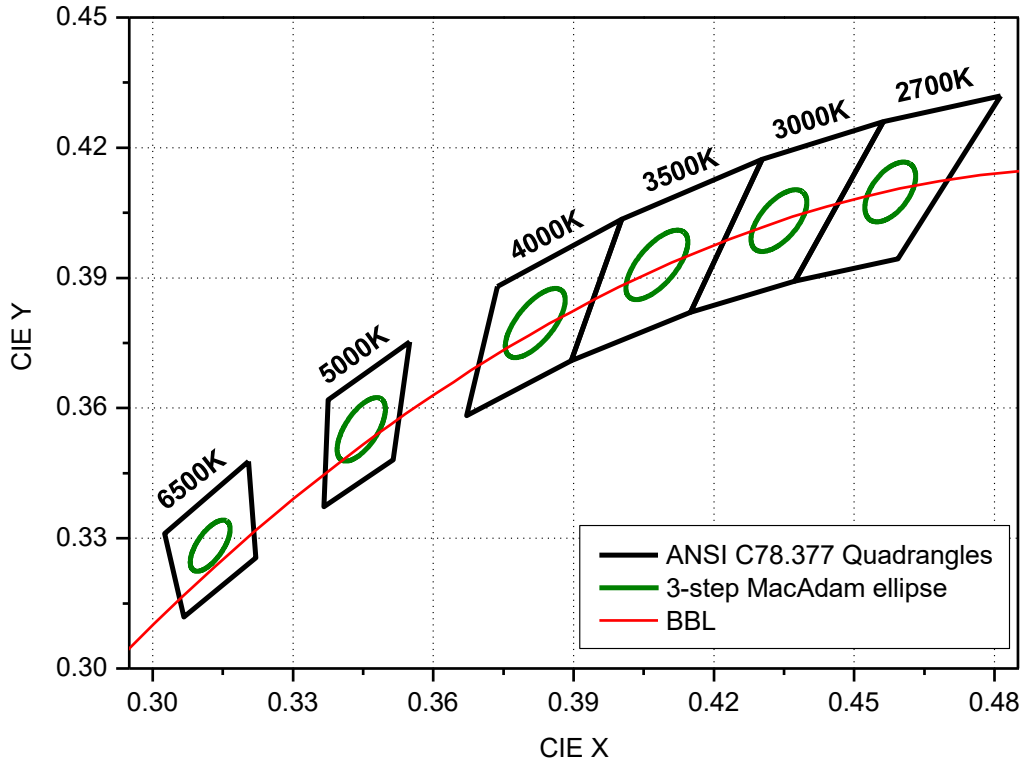

**Table 5. 3-step MacAdam Ellipse Color Bin Definitions**

Color Region	CCT (K)	Center Point		Major Axis (a)	Minor Axis (b)	Rotation Angle ( $\theta$ )
		CIE x	CIE y			
3-step MacAdam Ellipse	6500	0.3123	0.3283	0.00669	0.00285	58.38
	5000	0.3446	0.3551	0.00822	0.00354	59.62
	4000	0.3818	0.3797	0.00939	0.00402	54.00
	3500	0.4078	0.3930	0.00951	0.00417	52.97
	3000	0.4339	0.4033	0.00834	0.00408	53.17
	2700	0.4578	0.4101	0.00774	0.00411	57.28

**Notes :**

- (1) The chromaticity center refers to ANSI C78.377:2015.
- (2) (a), (b), and ( $\theta$ ) indicate the major axis length, the minor axis length, and the rotation angle from the X axis of the ellipse bin, respectively.

## Mechanical Dimensions

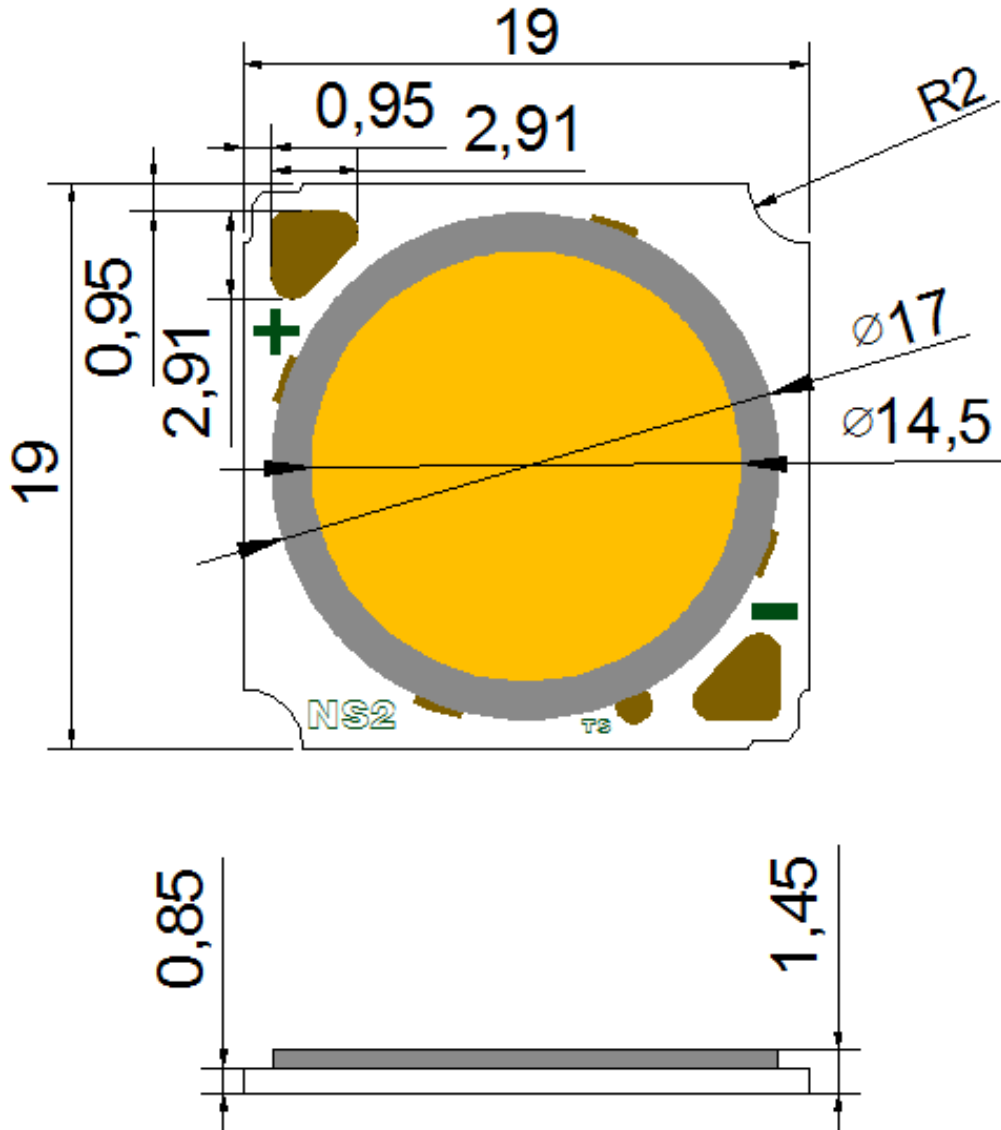

### Notes :

1. All dimensions are in millimeters.
2. Not to scale
3. Undefined tolerance is  $\pm 0.2$ mm



## Packaging Specification

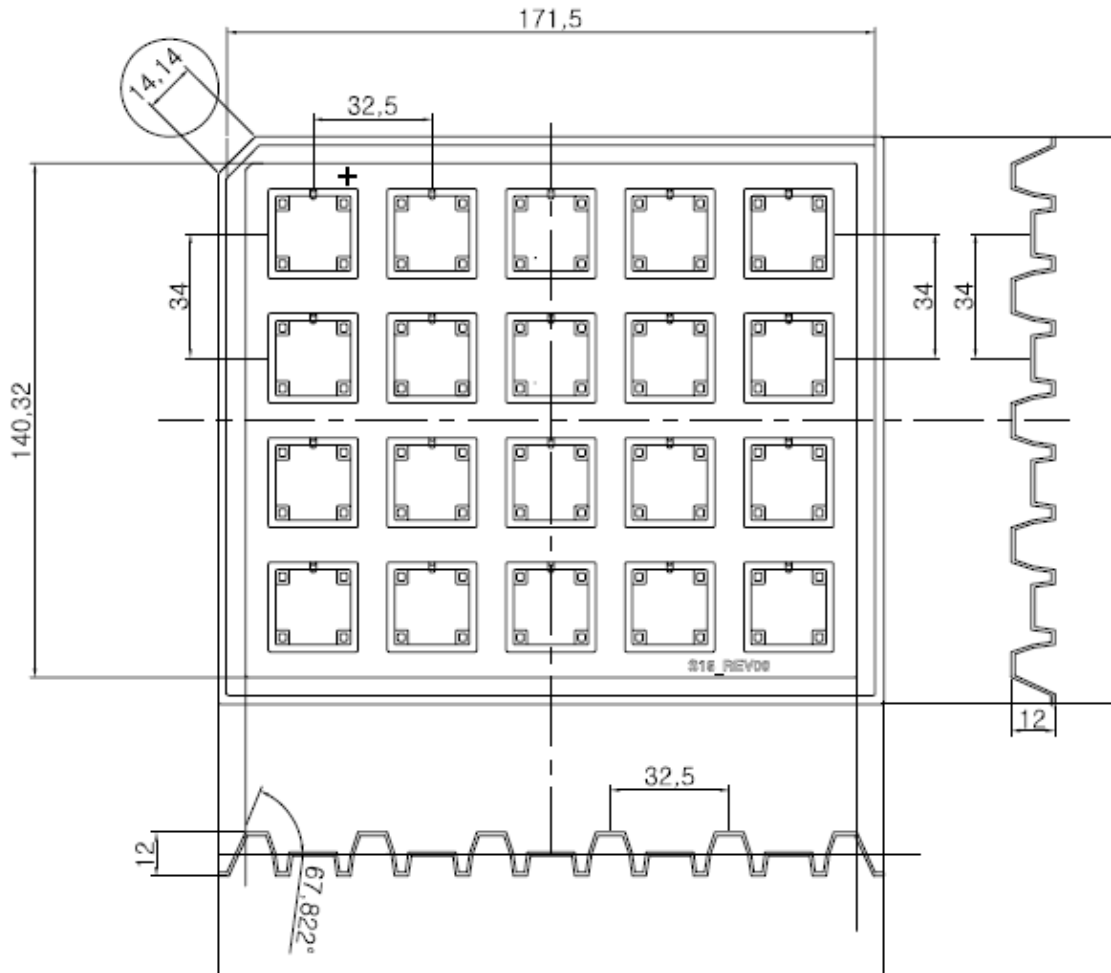

### Notes :

- (1) Quantity : 20pcs/Tray
- (2) All dimensions are in millimeters (tolerance :  $\pm 0.3$ )
- (3) Not to scale

### Aluminum Bag

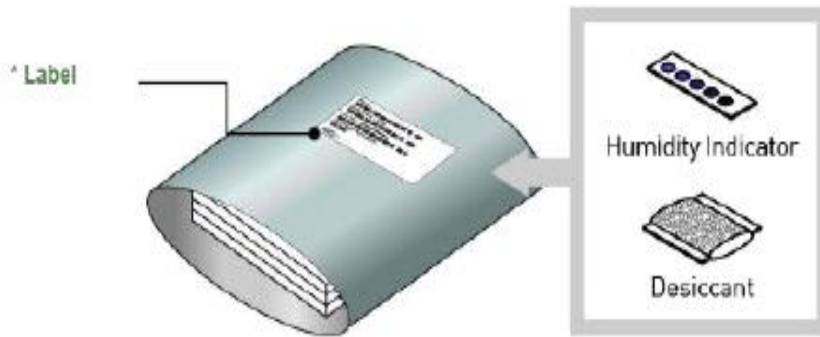



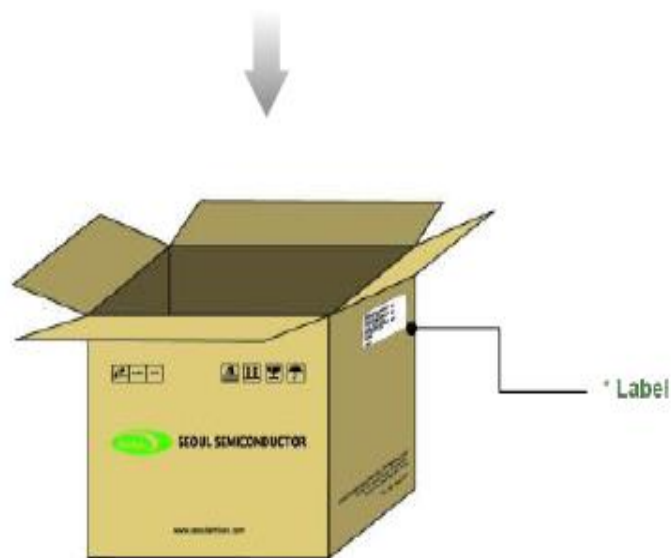

### Outer Box



#### Notes :

- (1) Heat Sealed after packing (Use Zipper Bag)
- (2) Quantity : 1Tray(20pcs) /Bag
- (3) Smallest packing quantity : 3Bags(60pcs) / small box

## Product Nomenclature

**RANK : Z<sub>1</sub>Z<sub>1</sub>Z<sub>2</sub>Z<sub>2</sub>Z<sub>3</sub>Z<sub>4</sub>**  
  
**QUANTITY : 20**  
  
**LOT NUMBER : Y<sub>1</sub>Y<sub>2</sub>Y<sub>3</sub>Y<sub>4</sub>Y<sub>5</sub>Y<sub>6</sub>Y<sub>7</sub>Y<sub>8</sub>Y<sub>9</sub>Y<sub>10</sub> – Y<sub>11</sub>Y<sub>12</sub>Y<sub>13</sub>Y<sub>14</sub>Y<sub>15</sub>Y<sub>16</sub>Y<sub>17</sub>**  
  
**SSC PART NUMBER : X<sub>1</sub>X<sub>2</sub>X<sub>3</sub>X<sub>4</sub>X<sub>5</sub>X<sub>6</sub>X<sub>7</sub>X<sub>8</sub>X<sub>9</sub>**  
  

**Table 6. Part Numbering System : X<sub>1</sub>X<sub>2</sub>X<sub>3</sub>X<sub>4</sub>X<sub>5</sub>X<sub>6</sub>X<sub>7</sub>X<sub>8</sub>X<sub>9</sub>**

Part Number Code	Description	Part Number	Value
X <sub>1</sub>	Company	S	
X <sub>2</sub>	Package series	A	
X <sub>3</sub> X <sub>4</sub>	Color Specification	WS	SunLike
X <sub>5</sub> X <sub>6</sub>	LES size	15	
X <sub>7</sub>	Chip Array	6	Series
X <sub>8</sub>	Chip Array	4	Parallel
X <sub>9</sub>	Revision number	A	

**Table 7. Lot Numbering System : Y<sub>1</sub>Y<sub>2</sub>Y<sub>3</sub>Y<sub>4</sub>Y<sub>5</sub>Y<sub>6</sub>Y<sub>8</sub>Y<sub>9</sub>Y<sub>10</sub> – Y<sub>11</sub>Y<sub>12</sub>Y<sub>13</sub>Y<sub>14</sub>Y<sub>15</sub>Y<sub>16</sub>Y<sub>17</sub>**

Lot Number Code	Description
Y <sub>1</sub> Y <sub>2</sub> Y <sub>3</sub> Y <sub>4</sub> Y <sub>5</sub>	Date of box packing
Y <sub>6</sub> Y <sub>7</sub> Y <sub>8</sub> Y <sub>9</sub> Y <sub>10</sub>	Date of label order
Y <sub>11</sub> Y <sub>12</sub> Y <sub>13</sub> Y <sub>14</sub> Y <sub>15</sub> Y <sub>16</sub> Y <sub>17</sub>	Item code

## Handling of Silicone Resin for LEDs

- (1) During processing, mechanical stress on the surface should be minimized as much as possible. Sharp objects of all types should not be used to pierce the sealing compound.



- (2) In general, LEDs should only be handled from the side. By the way, this also applies to LEDs without a silicone sealant, since the surface can also become scratched.



- (3) Silicone differs from materials conventionally used for the manufacturing of LEDs. These conditions must be considered during the handling of such devices. Compared to standard encapsulants, silicone is generally softer, and the surface is more likely to attract dust. As mentioned previously, the increased sensitivity to dust requires special care during processing. In cases where a minimal level of dirt and dust particles cannot be guaranteed, a suitable cleaning solution must be applied to the surface after the soldering of wire.
- (4) Seoul Semiconductor suggests using isopropyl alcohol for cleaning. In case other solvents are used, it must be assured that these solvents do not dissolve the package or resin. Ultrasonic cleaning is not recommended. Ultrasonic cleaning may cause damage to the LED.
- (5) Please do not mold this product into another resin (epoxy, urethane, etc) and do not handle this product with acid or sulfur material in sealed space.
- (6) Avoid leaving fingerprints on silicone resin parts.

## Precaution for Use

### (1) Storage

To avoid the moisture penetration, we recommend storing LEDs in a dry box with a desiccant . The recommended storage temperature range is 5°C to 30°C and a maximum humidity of RH50%.

### (2) Use Precaution after Opening the Packaging

Use SMT techniques properly when you solder the LED as separation of the lens may affect the light output efficiency.

Pay attention to the following:

#### a. Recommend conditions after opening the package

- Sealing / Temperature : 5 ~ 40°C Humidity : less than RH30%

#### b. If the package has been opened more than 4 week(MSL\_2a) or the color of the desiccant changes, components should be dried for 10-12hr at 60±5°C

### (3) Radioactive exposure is not considered for the products listed here in.

(4) Gallium arsenide is used in some of the products listed in this publication. These products are dangerous if they are burned or shredded in the process of disposal. It is also dangerous to drink the liquid or inhale the gas generated by such products when chemically disposed of.

(5) This device should not be used in any type of fluid such as water, oil, organic solvent and etc. When washing is required, IPA (Isopropyl Alcohol) should be used.

(6) When the LEDs are in operation the maximum current should be decided after measuring the package temperature.

(7) LEDs must be stored in a clean environment. We recommend LEDs store in nitrogen-filled container.

(8) The appearance and specifications of the product may be modified for improvement without notice.

(9) Long time exposure of sunlight or occasional UV exposure will cause lens discoloration.

(10) Attaching LEDs, do not use adhesive that outgas organic vapor.

(11) The driving circuit must be designed to allow forward voltage only when it is ON or OFF. If the reverse voltage is applied to LED, migration can be generated resulting in LED damage.

(12) Please do not touch any of the circuit board, components or terminals with bare hands or metal while circuit is electrically active.

## Precaution for Use

(13) VOCs (Volatile organic compounds) emitted from materials used in the construction of fixtures can penetrate silicone encapsulants of LEDs and discolor when exposed to heat and photonic energy. The result can be a significant loss of light output from the fixture. Knowledge of the properties of the materials selected to be used in the construction of fixtures can help prevent these issues.

(14) LEDs are sensitive to Electro-Static Discharge (ESD) and Electrical Over Stress (EOS). Below is a list of suggestions that Seoul Semiconductor purposes to minimize these effects.

### a. ESD (Electro Static Discharge)

Electrostatic discharge (ESD) is defined as the release of static electricity when two objects come into contact. While most ESD events are considered harmless, it can be an expensive problem in many industrial environments during production and storage. The damage from ESD to LEDs may cause the product to demonstrate unusual characteristics such as:

- Increase in reverse leakage current lowered turn-on voltage
- Abnormal emissions from the LED at low current

The following recommendations are suggested to help minimize the potential for an ESD event.

One or more recommended work area suggestions:

- Ionizing fan setup
- ESD table/shelf mat made of conductive materials
- ESD safe storage containers

One or more personnel suggestion options:

- Antistatic wrist-strap
- Antistatic material shoes
- Antistatic clothes

Environmental controls:

- Humidity control (ESD gets worse in a dry environment)

## Precaution for Use

### b. EOS (Electrical Over Stress)

Electrical Over-Stress (EOS) is defined as damage that may occur when an electronic device is subjected to a current or voltage that is beyond the maximum specification limits of the device. The effects from an EOS event can be noticed through product performance like:

- Changes to the performance of the LED package  
(If the damage is around the bond pad area and since the package is completely encapsulated the package may turn on but flicker show severe performance degradation.)
- Changes to the light output of the luminaire from component failure
- Components on the board not operating at determined drive power

Failure of performance from entire fixture due to changes in circuit voltage and current across total circuit causing trickle down failures. It is impossible to predict the failure mode of every LED exposed to electrical overstress as the failure modes have been investigated to vary, but there are some common signs that will indicate an EOS event has occurred:

- Damaged may be noticed to the bond wires (appearing similar to a blown fuse)
- Damage to the bond pads located on the emission surface of the LED package  
(shadowing can be noticed around the bond pads while viewing through a microscope)
- Anomalies noticed in the encapsulation and phosphor around the bond wires.
- This damage usually appears due to the thermal stress produced during the EOS event.

### c. To help minimize the damage from an EOS event Seoul Semiconductor recommends utilizing:

- A surge protection circuit
- An appropriately rated over voltage protection device
- A current limiting device

## Company Information

### Published by

Seoul Semiconductor © 2013 All Rights Reserved.

### Company Information

Seoul Semiconductor ([www.SeoulSemicon.com](http://www.SeoulSemicon.com)) manufactures and packages a wide selection of light emitting diodes (LEDs) for the automotive, general illumination/lighting, Home appliance, signage and back lighting markets. The company is the world's fifth largest LED supplier, holding more than 10,000 patents globally, while offering a wide range of LED technology and production capacity in areas such as "nPola", "Acrich", the world's first commercially produced AC LED, and "Acrich MJT - Multi-Junction Technology" a proprietary family of high-voltage LEDs.

The company's broad product portfolio includes a wide array of package and device choices such as Acrich and Acirch2, high-brightness LEDs, mid-power LEDs, side-view LEDs, and through-hole type LEDs as well as custom modules, displays, and sensors.

### Legal Disclaimer

Information in this document is provided in connection with Seoul Semiconductor products. With respect to any examples or hints given herein, any typical values stated herein and/or any information regarding the application of the device, Seoul Semiconductor hereby disclaims any and all warranties and liabilities of any kind, including without limitation, warranties of non-infringement of intellectual property rights of any third party. The appearance and specifications of the product can be changed to improve the quality and/or performance without notice.